



Reciprocating Shakers



Providing Consistent, Repeatable Reciprocating Shaking Action for a Variety of Applications

OHAUS Reciprocating Shakers are designed for a range of applications including cell cultures and extraction procedures that require accurate, repeatable results. Our shakers are designed to provide consistent, uniform shaking action. The back-and-forth reciprocating motion has a 19 mm stroke length. Permanently lubricated ball bearings and maintenance-free, brushless DC motor provide reliable service and continuous-duty operation.

Standard Features Include:

- A flexible unit for the lab - our multi-purpose Reciprocating Shakers can be customized to fit your unique workflow needs using a wide variety of accessories.
- Reciprocating motion is ideal for gentle-to-vigorous mixing of separatory funnels with the sturdy separatory funnel platform. Other optional platforms for flask clamps, media bottles and tube racks.
- Designed for safety - speed ramping feature slowly increases speed to avoid splashing. Load sensor detects unbalanced conditions and automatically reduces to a safe speed to protect samples.

Specifications Reciprocating Shakers

Model	SHRC0719DG
Control	Digital
Motion	Reciprocating, 19 mm
Speed Range	20 rpm – 300 rpm
Speed Accuracy	± 1 rpm, Above 100 rpm ± 1% of set speed
Timer	1 second – 160 hours
Capacity	6.8 kg
Calibration	Speed calibration
Communication	RS232 (Included)
Working Environment	-10 °C – 60 °C, 80% Relative Humidity, non-condensing
Drive System	Brushless DC Motor; Single Eccentric
Included Tray (L × W)	279 mm × 330 mm
Tray Construction	Aluminum
Overall Dimensions (L × W × H)	413 mm × 355 mm × 149 mm
Net Weight	21.8 kg
Power	230V, 2.5A, 50/60Hz
Power Consumption	40 W

Other Standard Features and Equipment

Built-in tray with a non-slip rubber mat (included), overload protection with audible and visual signals, audible alarm

Compliance

- **Product Safety:** EN 61010-1, EN 61010-2-051
- **Electromagnetic Compatibility:** EN 61326-1 Class A, Industrial Environments
- **Compliance Marks:** CE; RCM; TÜV SÜD

Applications

Chemical extractions, blood sample mixing, gel staining, cell cultures, solubility studies

Dimensions

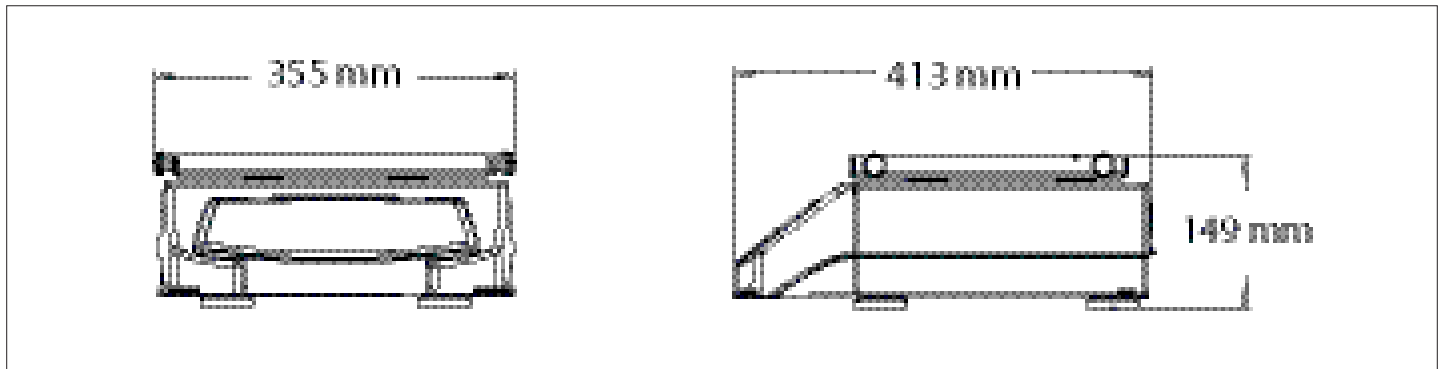

Accessories Reciprocating Shakers

Platforms for Reciprocating Shakers	
Item No.	Description
30400052	Universal Platform, 28 × 33 cm, S/S
30400053	Universal Platform, 33 × 33 cm, S/S
30400054	Universal Platform, 46 × 46 cm, S/S
30400056	Universal Platform, 61 × 46 cm, S/S
30400066	Culture Platform with Mat, 46 × 46 cm
30400067	Culture Platform with Mat, 46 × 61 cm
30400075	Dedicated Platform, 33 × 33 cm, 125 mL
30400076	Dedicated Platform, 33 × 33 cm, 250 mL
30400077	Dedicated Platform, 33 × 33 cm, 500 mL
30400078	Dedicated Platform, 33 × 33 cm, 1000 mL
30400079	Dedicated Platform, 46 × 46 cm, 125 mL
30400080	Dedicated Platform, 46 × 46 cm, 250 mL
30400081	Dedicated Platform, 46 × 46 cm, 500 mL
30400082	Dedicated Platform, 46 × 46 cm, 1000 mL
30400083	Separatory Funnel Platform 46 × 46 cm



30400052
Universal Platform, 28 × 33 cm, S/S

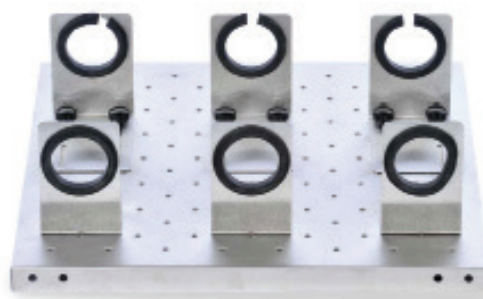

30400083
Separatory Funnel Platform, 46 × 46 cm

Accessories for Universal Platform—28 × 33 cm (Item No. 30400052)		
Item No.	Description	Max. per Platform
30400084	Flask Clamp, 10 mL	60
30400085	Flask Clamp, 25 mL	25
30400086	Flask Clamp, 50 mL	13
30400087	Flask Clamp, 125 mL	10
30400088	Flask Clamp, 250 mL	9
30400089	Flask Clamp, 500 mL	7
30400090	1 Liter Erlenmeyer Flask Clamp	4
30400097	500 mL Media Bottle Clamp	5
30400098	1000 mL Media Bottle Clamp	2
30400099	Flask Clamp PVC 125 mL	10
30400100	Flask Clamp PVC 250 mL	8
30400101	Flask Clamp PVC 500 mL	5
30400102	Flask Clamp PVC 1000 mL	2
30400105	Test Tube Rack 13 mm Pivoting	1
30400106	Test Tube Rack 16 mm Pivoting	1
30400107	Test Tube Rack 20 mm Pivoting	1
30400108	Test Tube Rack 25 mm Pivoting	1
30400109	Test Tube Rack 30 mm Pivoting	1
30400114	Micro Tube Rack	2
30400115	Test Tube Rack 10-13 mm Diameter	2
30400116	Test Tube Rack 14-16 mm Diameter	2
30400117	Test Tube Rack 18-20 mm Diameter	2
30400118	Test Tube Rack 22-25 mm Diameter	2
30400119	Test Tube Rack For 15 mL Tubes	2
30400120	Test Tube Rack For 50 mL Tubes	2
30400104	Clamp Microplate Stainless Steel	4
30400060	Rubber Mat, 28 × 33 cm	1

Accessories for Universal Platform—33 × 33 cm (Item No. 30400053)		
Item No.	Description	Max. per Platform
30400084	Flask Clamp, 10 mL	60
30400085	Flask Clamp, 25 mL	30
30400086	Flask Clamp, 50 mL	15
30400087	Flask Clamp, 125 mL	12
30400088	Flask Clamp, 250 mL	12
30400089	Flask Clamp, 500 mL	8
30400090	1 Liter Erlenmeyer Flask Clamp	4
30400091	2 Liter Erlenmeyer Flask Clamp	3
30400092	2.8 Liter Erlenmeyer Flask Clamp	1
30400093	3 Liter Erlenmeyer Flask Clamp	1
30400094	4 Liter Erlenmeyer Flask Clamp	1
30400095	5 Liter Erlenmeyer Flask Clamp	1
30400096	6 Liter Erlenmeyer Flask Clamp	1
30400097	500 mL Media Bottle Clamp	6
30400098	1000 mL Media Bottle Clamp	5
30400099	Flask Clamp PVC 125 mL	12
30400100	Flask Clamp PVC 250 mL	10
30400101	Flask Clamp PVC 500 mL	6
30400102	Flask Clamp PVC 1000 mL	4
30400103	Flask Clamp PVC 2000 mL	3
30400105	Test Tube Rack 13 mm Pivoting	2
30400106	Test Tube Rack 16 mm Pivoting	2
30400107	Test Tube Rack 20 mm Pivoting	2
30400108	Test Tube Rack 25 mm Pivoting	2
30400109	Test Tube Rack 30 mm Pivoting	2
30400114	Micro Tube Rack	2
30400115	Test Tube Rack 10-13 mm Diameter	2
30400116	Test Tube Rack 14-16 mm Diameter	2
30400117	Test Tube Rack 18-20 mm Diameter	2
30400118	Test Tube Rack 22-25 mm Diameter	2
30400119	Test Tube Rack For 15 mL Tubes	2
30400120	Test Tube Rack For 50 mL Tubes	2
30400104	Clamp Microplate Stainless Steel	6
30400061	Rubber Mat, 33 × 33 cm	1

Accessories Reciprocating Shakers

Accessories for Universal Platform—46 × 46 cm (Item No. 30400054)		
Item No.	Description	Max. per Platform
30400084	Flask Clamp, 10 mL	113
30400085	Flask Clamp, 25 mL	64
30400086	Flask Clamp, 50 mL	32
30400087	Flask Clamp, 125 mL	20
30400088	Flask Clamp, 250 mL	20
30400089	Flask Clamp, 500 mL	13
30400090	1 Liter Erlenmeyer Flask Clamp	8
30400091	2 Liter Erlenmeyer Flask Clamp	5
30400092	2.8 Liter Erlenmeyer Flask Clamp	2
30400093	3 Liter Erlenmeyer Flask Clamp	2
30400094	4 Liter Erlenmeyer Flask Clamp	4
30400095	5 Liter Erlenmeyer Flask Clamp	4
30400096	6 Liter Erlenmeyer Flask Clamp	2
30400097	500 mL Media Bottle Clamp	16
30400098	1000 mL Media Bottle Clamp	10
30400099	Flask Clamp PVC 125 mL	20
30400100	Flask Clamp PVC 250 mL	18
30400101	Flask Clamp PVC 500 mL	12
30400102	Flask Clamp PVC 1000 mL	8
30400103	Flask Clamp PVC 2000 mL	4
30400105	Test Tube Rack 13 mm Pivoting	2
30400106	Test Tube Rack 16 mm Pivoting	2
30400107	Test Tube Rack 20 mm Pivoting	2
30400108	Test Tube Rack 25 mm Pivoting	2
30400109	Test Tube Rack 30 mm Pivoting	2
30400110	Test Tube Rack 10-14 mm Stationary	3
30400111	Test Tube Rack 16-20 mm Stationary	3
30400112	Test Tube Rack 21-25 mm Stationary	3
30400113	Test Tube Rack 50 mL Tubes Stationary	3
30400114	Micro Tube Rack	4
30400115	Test Tube Rack 10-13 mm Diameter	4
30400116	Test Tube Rack 14-16 mm Diameter	4
30400117	Test Tube Rack 18-20 mm Diameter	4
30400118	Test Tube Rack 22-25 mm Diameter	4
30400119	Test Tube Rack For 15 mL Tubes	4
30400120	Test Tube Rack For 50 mL Tubes	4
30400104	Clamp Microplate Stainless Steel	12
30400062	Rubber Mat, 46 × 46 cm	1

Accessories for Universal Platform—61 × 46 cm (Item No. 30400056)		
Item No.	Description	Max. per Platform
30400084	Flask Clamp, 10 mL	158
30400085	Flask Clamp, 25 mL	88
30400086	Flask Clamp, 50 mL	44
30400087	Flask Clamp, 125 mL	28
30400088	Flask Clamp, 250 mL	28
30400089	Flask Clamp, 500 mL	20
30400090	1 Liter Erlenmeyer Flask Clamp	12
30400091	2 Liter Erlenmeyer Flask Clamp	6
30400092	2.8 Liter Erlenmeyer Flask Clamp	3
30400093	3 Liter Erlenmeyer Flask Clamp	3
30400094	4 Liter Erlenmeyer Flask Clamp	4
30400095	5 Liter Erlenmeyer Flask Clamp	4
30400096	6 Liter Erlenmeyer Flask Clamp	3
30400097	500 mL Media Bottle Clamp	20
30400098	1000 mL Media Bottle Clamp	13
30400099	Flask Clamp PVC 125 mL	28
30400100	Flask Clamp PVC 250 mL	25
30400101	Flask Clamp PVC 500 mL	16
30400102	Flask Clamp PVC 1000 mL	10
30400103	Flask Clamp PVC 2000 mL	6
30400105	Test Tube Rack 13 mm Pivoting	3
30400106	Test Tube Rack 16 mm Pivoting	3
30400107	Test Tube Rack 20 mm Pivoting	3
30400108	Test Tube Rack 25 mm Pivoting	3
30400109	Test Tube Rack 30 mm Pivoting	3
30400110	Test Tube Rack 10-14 mm Stationary	5
30400111	Test Tube Rack 16-20 mm Stationary	5
30400112	Test Tube Rack 21-25 mm Stationary	5
30400113	Test Tube Rack 50 mL Tubes Stationary	5
30400114	Micro Tube Rack	6
30400115	Test Tube Rack 10-13 mm Diameter	6
30400116	Test Tube Rack 14-16 mm Diameter	6
30400117	Test Tube Rack 18-20 mm Diameter	6
30400118	Test Tube Rack 22-25 mm Diameter	6
30400119	Test Tube Rack For 15 mL Tubes	6
30400120	Test Tube Rack For 50 mL Tubes	6
30400104	Clamp Microplate Stainless Steel	18
30400063	Rubber Mat, 46 × 61 cm	1



30400096
6 Liter Erlenmeyer Flask Clamp



30400102
Flask Clamp PVC 1000 mL



30400093
3 Liter Erlenmeyer Flask Clamp



30400120
Test Tube Rack For 50 mL Tubes

OHAUS Asia/Pacific Headquarters

7F, Block 33, 680 Guiping Road
Shanghai 200233
China

e-mail: APmarketing@ohaus.com
Tel: +86 21 64855408

www.ohaus.com

The management system governing the manufacture of this product is ISO 9001:2015 certified.

SAP Literature #

